

6FKRWWN\ %ULGJH 5HFWLILHU

0D[LPX5PDWLQ0G0HFW0K0D0FWHULVWLFV

5DWLQWf &DPEL M0W SHUX00X0M0KHU0ZLH00Ap0G .g SWXEDb...f0 AW p^(V0 `AW D R#iCsÓ`



RATINGS AND CHARACTERISTICS CURVES

3HDN)RUZDUG 6XUDJH &XUUHQW \$QVWDQHRXV)RUZDUG &XUUHQW \$YHUDJH 5HFWLILHG 2XWSXW &XUUHQW

-XQFWLRQ &DSDFLWDQFH S) ,QVWDQHRXV 5HYHUH \$XUUHQW)RUZDUG &DSDFLWDQFH

)LJ \$YHUDJH 5HFWLILHG 2XWSXW &XUUHQW)LJ 7\SLFDO 5HYHUH &KDUDFWHULVWLF

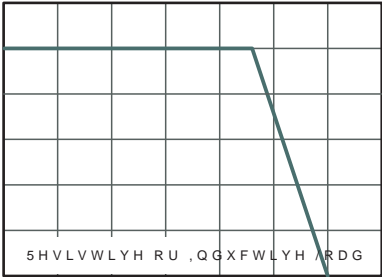

&DVH 7HPSHUDWXUH °&

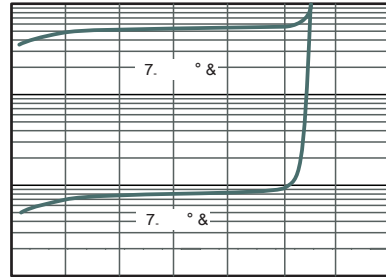

SHUFHQW R3IHDDW5HG YHUVH 9ROWDJH

)LJ 7\SLFDO ,QVWDQHRXV)RUZDUG &KDUDFWHULVWLF

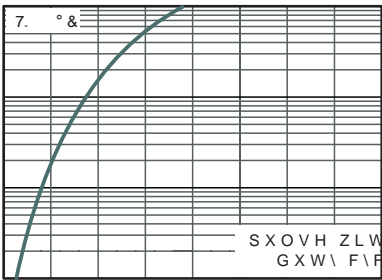

,QVWDQHRXV)RUZDUG 9ROWDJH 9

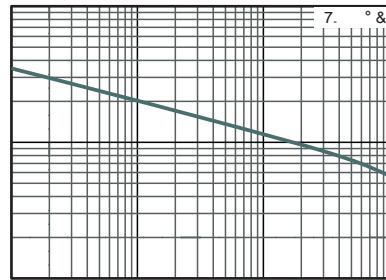

5HYHUH 9ROWDJH 9

)LJ 0D[LXP 1RQ 5HSHWLWLYH 3HDN)RUZDUG 6XUDJH &XUUHQW

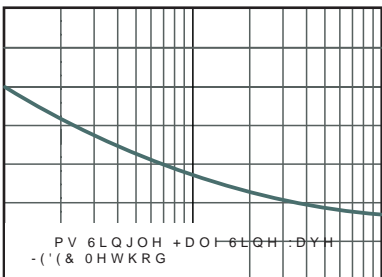

1XPEHU RI &\FOHV



06%PHFKDQLFWD

81,7		\$	&	'	((/	H	E	
PP	PD[<i>f</i>
	PLQ									
PLO	PD[
	PLQ									

06%6XJJHVVHG 3DG /D\RXW

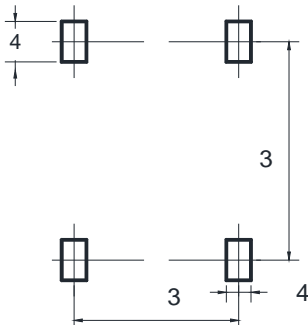

81,7		3	3	4	4
PP	PLQ				
PD	PLQ				

'LPHQVILR/QR/LOOLPHWHUV

0DUNLQJ ,QIRUPDWLRQ

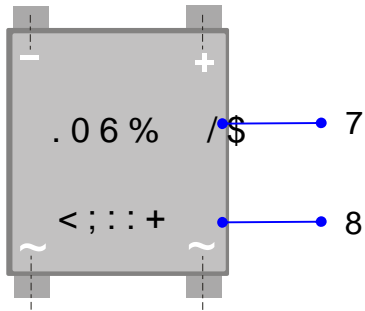

7 3URGXFW PRGHO .06% / \$
8 3' & LQIRUPDWLRQ

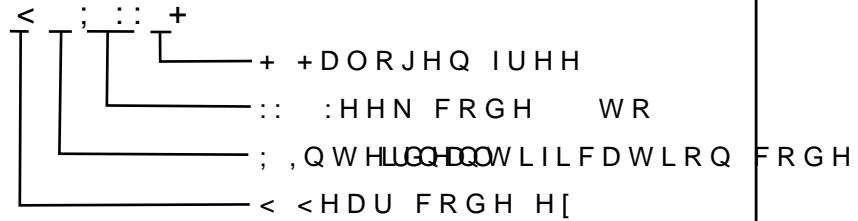

3DFNDJLQJ ,QIRUPDWLRQ

5HHO 'LPHQVLRQV

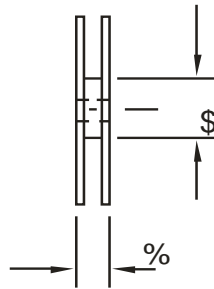
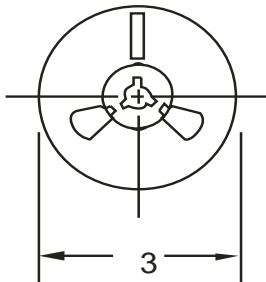

,QVLGH %R[

2XWVLGH %R[

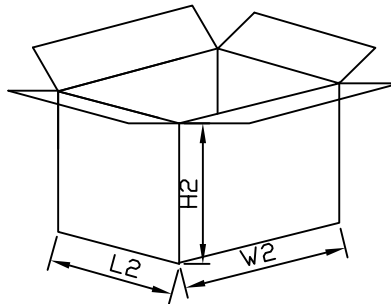
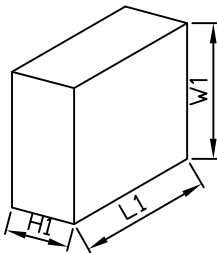

3DFNDJLQJ ,QIRUPDWLRQ

12	81,	5HHO 'LPHQVLR			,QVLGH %R[2XWVLGH %R[
			\$	%	/	:	+	/	:	+
6L]H	PP									
47<	3&6	6PDOGDFW DJH3&6 UHHO			3&6 UHHO RWDO			3&6 FDUERLQ RWDO		
1RWH		7ROHUDQFH PP" PP			PP" PP			PP" PP		